



HWELEN
OILFIELD SERVICES

PRODUCT CATALOGUE



**HWELEN OILFIELD SERVICES
CARE ABOUT YOUR NEED**

CONTENS

OUR PROFILE..... - 2 -

OILFIELD MATERIAL..... - 3 -

HOISTING EQUIPMENT - 4 -

ROTARY EQUIPMENT..... - 5 -

PUMPING & HIGH PRESSURE DISCHARGE SYSTEM - 7 -

RIG FLOOR EQUIPMENT - 10 -

DRILLING & FISHING TOOLS..... - 16 -

CASING TOOLS - 27 -

SUBMERSIBLE PUMPS - 32 -

OILFIELD SERVICES - 36 -

OUR MISSION - 37 -

OUR PROFILE

HWELLEN was built with an objective to become a trusted supplier of dependable resources in China. We are determined to provide our clients with right things to keep their rigs drilling at a short notice and reasonable cost.

Today we are selected by our clients worldwide as a partner because our services are managed and conducted by highly qualified and seasoned practitioners from all major facets of the oil industry. We put our effort to provide technical knowledge and quality material for their needs. They say yes to our services and guess you will say so soon.

OILFIELD MATERIAL

- **HOISTING EQUIPMENT**
- **ROTARY EQUIPMENT**
- **PUMPING & HIGH PRESSURE DISCHARGE SYSTEM**
- **RIG FLOOR EQUIPMENT**
- **DRILLING & FISHING TOOLS**
- **CASING TOOLS**
- **SUBMERSIBLE PUMPS**

HOISTING EQUIPMENT

TRAVELING BLOCKS

- 190T/250T/350T/500T

HOOKS

- 190T/250/350T/500T

HOOK BLOCKS

- 150T/180T/190T/250T



PENUMATIC TUBE CLUTCH

COMMON TYPE	LT300/100	LT500/125 T	LT600/125 T	LT700/200	LT700/135CB C	LT800/135
VENTILATED TYPE	AVB500/200	LT500/250 T	AVB600/250	LT700/250 T	LT700/135DY	LT800/250 T



ROTARY EQUIPMENT

SWIVELS

- 1250kN/1700kN/2250kN/3150kN/4500kN

ROTARY TABLE

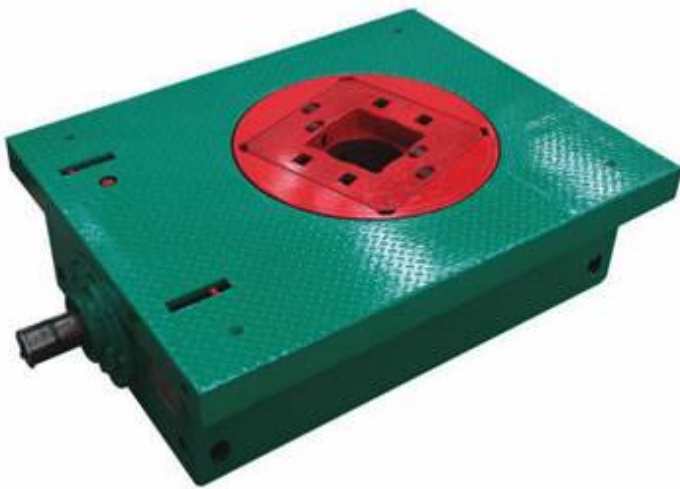

- ZP175/ZP275/ZP375/ZP495

BUSHING AND INSERT BOWLS

- Casing Bushings & Insert Bowls (CU, CUL & CB)
- Master Bushings & Insert Bowls (MSS, MSPC, MDSP, MSP & MPCH)

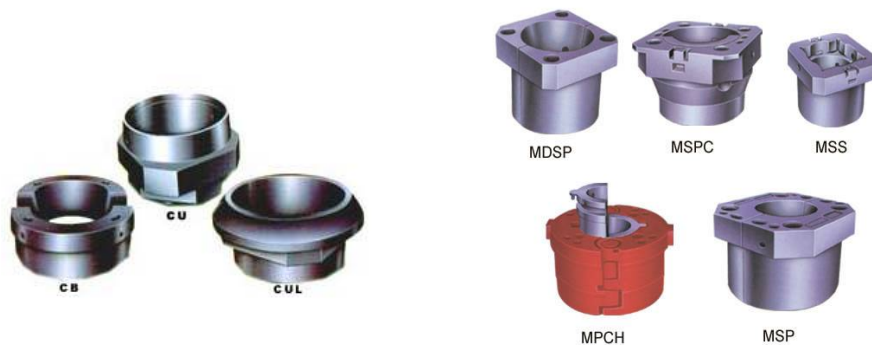

MASTER BUSHING ACCESSORIES

- Bit Breaker
- Bit Breaker Adapter Plate
- Lifting Slings



PUMPING & HIGH PRESSURE DISCHARGE SYSTEM

MUD PUMP FLOW END PARTS

•NOV/GARDNER DENVER/EMSCO/HH/LS-NOV/BOMCO



HIGH PRESSURE HOSES



- ROTARY DRILLING, VIBRATOR, MUD DELIVERY AND CEMENT HOSES
- FIRE RATED TENSORER HOSES
- JETTING HOSES
- HEAT TRACED HOSES

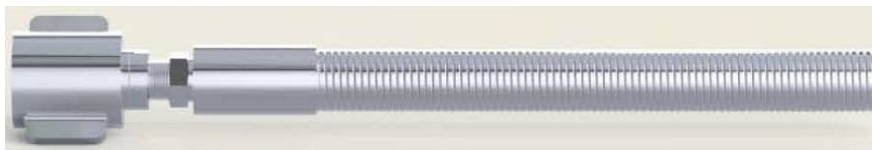

- FLAMESHIELD BOP HYDRAULIC HOSES
- BULK PRODUCT SUCTION & DELIVERY HOSES 10BAR/20BAR



- CHEMICAL SUCTION & DELIVERY HOSES 16BAR



- OIL SUCTION & DELIVERY HOSES 10BAR/20BAR

- OIL DELIVERY HOSES 10BAR/20BAR



- STEAM HOSES 17BAR

- POTABLE WATER SUCTION & DELIVERY HOSES 10BAR/20BAR

- WELDING CUTTING HOSES



- TWIN WELDING HOSES

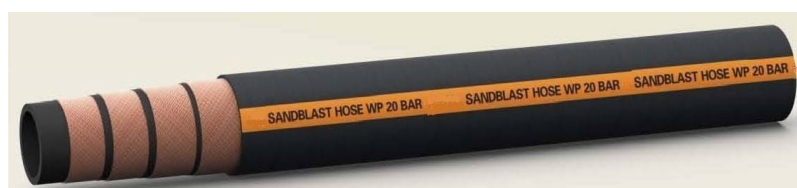

- SANDBLAST HOSES

- AIR HOSES 20BAR/30BAR/40BAR

- HYDRAULIC HOSES

RIG FLOOR EQUIPMENT

MANUAL TONGS

Manual Tongs are necessary tools applied to make up and break out pipes. Changing lug jaws and latch steps can adjust different handling sizes of the tongs. They are inspected and torque tested to API 7K.



- SDD type (4-17")
- DB type (3 1/2 -17")
- B type (3 3/8 – 13 3/8")
- SB type (3 1/2 – 13 3/8")
- C type (2 3/8 – 10 3/4")
- AAX type (2 7/8 -13 3/8")
- WWB type (2 3/8 – 10 3/4")
- LF type (2 3/8 7")
- Casing Tongs (13 3/8")

- Extended Casing Tongs (13/3/8 – 36")

ELEVATORS

- DD type (2 3/8 – 5 1/2")
- DDZ type (2 3/8 – 6 5/8")
- CDZ type (2 3/8 – 5 1/2")
- TA type (2 7/8 – 11 1/4")
- CD type (2 3/4 – 9 7/8")
- SX type (7 – 20")
- SLX type (3 1/2 – 14 1/4")
- Y Series Slip type (20 – 200Tons)
- SJ type (Auxiliary)
- SP type (Auxiliary)
- SJX type (Auxiliary)
- DDZH type (Hydraulic 2 3/8 – 7")
- CDZH type (Hydraulic 2 3/8 – 9 5/8")
- Air - operated type (3 1/2 – 8 5/8")

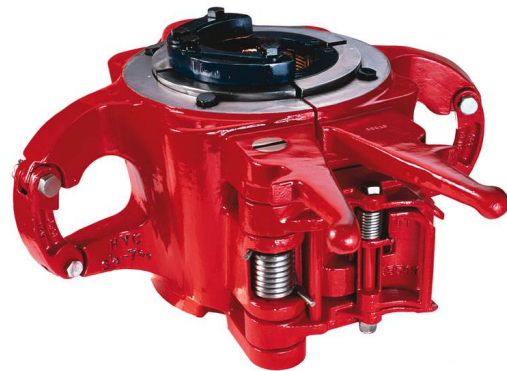

LINKS

Weldless links are forged with high-quality alloy steel. They are inspected and tested to API 8A/8C.

- Weldless links (150 - 450Tons)
- Perfection links (75 – 150 Tons)



DRILL COLLAR DOLLY LINK ADAPTER (150 Tons)

DRILL PIPE SLIPS

- SD type (2 3/8 – 7")
- B type (B Short, B Long and X Long 2 3/8 – 5 1/2")
- DU type (DU, DUL and SDU 2 3/8 – 7")

DRILL COLLAR SLIPS

- DCS type (S, R and L 3 – 14")
- A type (3 – 11 3/4")
- WT type (4 1/2 – 9 1/2")



CASING SLIPS

- UC-3 type (7 - 42")
- CMS type (4 1/2 - 30")

SAFETY CLAMP



- MP type (2 7/8 – 30 1/2")
- C & T type (1 1/8 – 15 5/8")

PNEUMATIC SLIPS

Pneumatic slips are suitable for all kinds of rotary tables for hoisting drill pipes and handling casings. Inspected and tested to API 7K.

SPIDERS

- SE type (2 3/8 – 24 1/2")
- C, E, HD & CHD type (1.315 – 7 5/8")



- QQP type (2 3/8 – 5’')
- TS Tubing type (1.05 – 5 3/4’')
- API type (2 3/8 – 10 3/4’')
- Casing type & Insert bowls (2 3/8 – 36’')

ROLLER KELLY BUSHINGS (2 1/2 – 6’')

SUCKER ROD ACCESSORIES

- Sucker Rod Elevators
- Sucker Rod Elevating Sockets
- Sucker Rod Hooks
- Sucker Rod Wrenches
- Sucker Rod Blowout Preventer



CASING & TUBING PROTECTORS (2 3/8 – 20’')

CASING & TUBING STABBING GUIDES (2 3/8 – 20’')

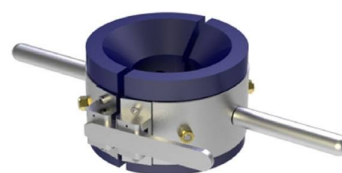

INSERTS & DIES FOR TONGS, CLAMPS, SLIPS, ELEVATORS & SPIDERS



DRILLING & FISHING TOOLS

We supply quality and dependable drilling and fishing tools for all well application. Inspected and tested to API 7-1.

DRILL COLLARS



- Slick type (3 1/8 – 11")
- Spiral type (3 3/8 – 11")
- Spiral type with elevator and slip groove (O.D. 101.6-222.2mm)

DRILL PIPES

- Integral Heavy Weight type (3 1/2 – 6 5/8")
- Integral Spiral Heavy Weight type (3 1/2 – 5")
- Kelly (2 1/2 – 6")

STABILIZERS



Integral Spiral Blade Stabilizer



Integral Straight Blade Stabilizer

- Integral Straight Blade type (Bit size 6 – 17 1/2")
- Integral Spiral Blade type (Bit size 6 – 28")
- Replaceable Sleeve Spiral type (Bit size 8 1/2 – 26")
- Non - rotating type (13 3/8 – 28")
- Float Valve type
- Spherical type (6 – 12 1/4")
- Hard Facing type (6 – 26")

HOLE OPENERS (12 1/4 – 36")



ROLLER REAMER (Hole size 6 1/8 – 36")

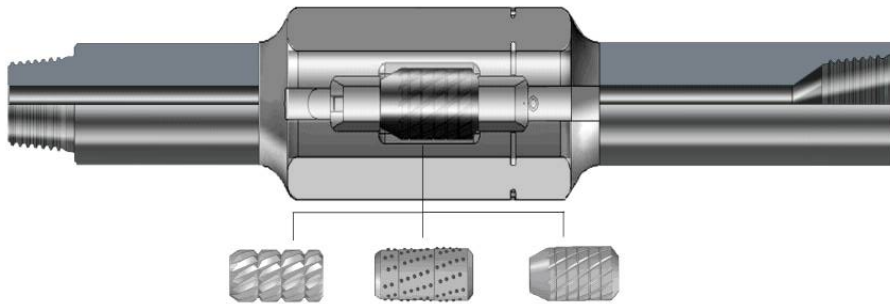

TOOL JOINT (4 1/8 – 6 5/8")

CROSS OVER SUB FOR KELLY, DRILL PIPE, DRILL COLLAR, BIT, SWIVEL AND FISHING

LIFTING CAB

SUB

- Drill Tool Lifting type
- Oriented Bent type (0 – 3.6)
- Float Valve type

CIRCULATING HEAD

VALVES

- Arrow Back Pressure Valve (35MPa)
- Drop - in Check Valve (70Mpa)

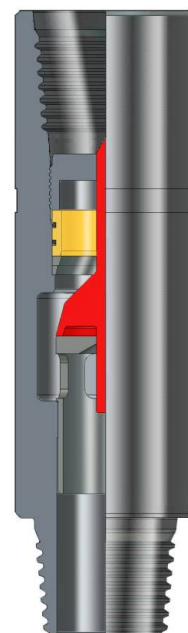

- Kelly Valve (35, 70, 105MPa)

INSIDE BOP (3 3/8 – 9 1/2")

CASING SCRAPER (C.Size 4 1/2 – 9 5/8")

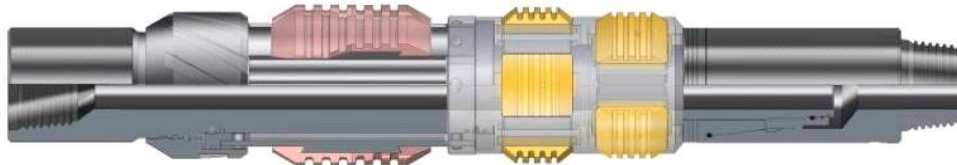

CASING PRESSURE TESTING PLUG (5 – 20")

DRIFT

- Casing type (4 1/2 – 7")
- Tube type (1 1/2 – 4")

DRILLING JARS

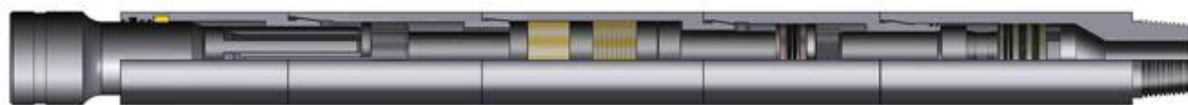

- Mechanical type (3 3/4 – 9")
- Full hydraulic type (3 1/8 – 9 1/2")
- Integral mechanical type (4 7/8 – 8")

- Hydro-mechanical type (3 3/4 – 8")
- Super fishing type (3 3/4 – 9")
- Hydraulic type (2 7/8 – 9")
- Surface bumper type (4 3/4 – 8")

JAR INTENSIFIER (2 7/8 – 9 1/2")



BUMPER SUB

- Fishing type (3 1/8 – 9 1/2")
- Lubricated fishing type (2 7/8 – 8")

SHOCK SUB



- Hydraulic type (3 3/4 – 14")

- Two-way type (4 3/4 - 11")
- Mechanical-hydraulic type (4 3/4 - 11")

HYDAULIC THRUSTER (3 1/4 – 13 3/8")

Hydraulic thruster can change the pressure drop of bit nozzle or down-hole motor into drill pressure, not only can solve the problems that drill pressure is difficult for applying in directional well, horizontal well, but also has the acting of heave compensator in off-land drilling. And it is capable to improve the stressed state of drilling tool, reduce fatigue damage of drilling tool and also increase drilling rate.

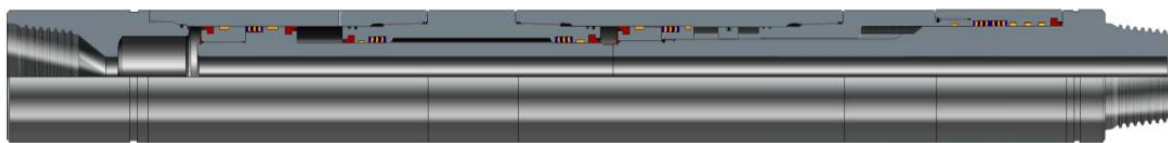

DRILL ACCELERATOR

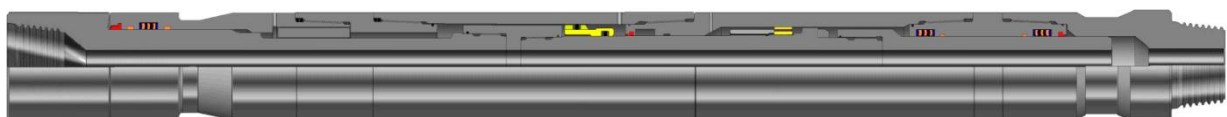

- Drilling type (4 3/4 – 9 1/2")
- Two action type (3 3/4 – 9 1/2")

SAFETY JOINT (3 3/4 – 8")

Safety Joint is a reliable device for fishing, milling and testing. It can be mounted on the necessary part of drill string. Moreover, it can bear all kinds of tension/pressure load and transitive torque. If necessary, it can be back away as to take out the pipes

string above Safety Joint during down-hole operation. When drilling-in again, it's easy to connect with Safety Joint well as for continued operation.

FISHING MAGNET (3 7/8 – 11 1/4")

Fishing Magnet is an external tool designed to retrieve small metal objects , such as milling shavings, bit cones, cutters, bearings, slips, tong pins, and hand tools by its permanent magnet from the bottom of the well so as to make fishing effective and purify the bottom of well. The scope of temperature can be $-85^{\circ}\text{C} \sim 250^{\circ}\text{C}$; unit suction can be 150N/C m^2 .



FISHING MULTIFUNCTION (3 3/4 – 15")

Fishing Multifunction is a new and ideal fishing tool for cleaning the bottom of well. It integrates the functions of fishing cup, fishing magnet and claw fishing basket into an organic whole. Therefore, it can be used for the fallen substances either fishing the metal particles or clawing the large sized gear wheel and tong's tooth.

JUNK SUB (4 – 9 5/8")

Junk Sub is an efficient tool used in milling or drilling operation. It is designed to capture cuttings that are too heavy to be circulated in the bottom of the hole.

RELEASING & CIRCULATING OVERSHOT (3 3/8 – 16")

Releasing & Circulating Overshot is an external fishing tool used for catch the fish with smooth external surface. Its circulation can be carried out under high pump pressure and the fish can be released on the inside of well. According to different uses, it may be equipped with some accessories, such as extension sub, wall hook, enlarged guide and etc.

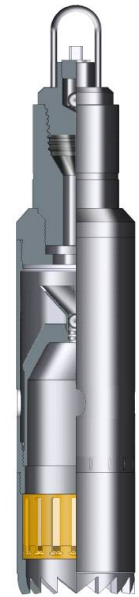

REVERSE CIRCULATING JUNK BASKET (3 5/16 – 20 3/16”)

Reverse Circulating Junk Basket is designed to remove small pieces of junk such as bit cones, hand tools, slips and etc. from the bottom of well. Its unique feature is utilizing the principle of reverse fluid circulation. Moreover, it can be used as a special coring tool.

GRAPPLE RELEASING SPEAR (1.26 – 19.13”)

Grapple Releasing Spear is an internal catch fishing tool. It is easy used to recover the lost drill string, tubing and casing, and can also be used in conjunction with internal cutter, bumper sub, etc. to finish cutting and recovering at the same time.

RELEASABLE REVERSING SPEAR (1.54 – 12.7”)

Releasable Reversing Spear is a tool designed to recover and back off the stuck pipe-shaped fish like drill pipe, oil tubing, etc. Back-off operation and fishing job are performed through the interior bore of the fish by using the spear. When catch the fishes, it cannot be lifted up. Thus, the held fishes can also be released.

TAPER TAP

Taper Tap is used for tapping and fishing the fallen substances in the hole from their inner bore, like oil tubes and drill pipes. It has higher fishing rate for items with coupling.

DIE COLLAR

Die Collar is a special tapping and fishing tool. Its operation is from the outside wall of the fallen pipes, such as oil tubes and drill pipes. It is more efficient for fallen items without hole or with blocked hole.

DOUBLE ACTING CASING SWAGE

Double Acting Casing Swage is a tool for down-hole casing's repair and redress, having double-acting function of up and down impacting, rotating and extruding outwardly.

CASING COMPENSATOR (4.48 – 15.28’')

Casing Compensator works as a connector when an old damaged casing needs to be replaced and removed out from down-hole, while a new casing needs to be put down. Patches are particularly well suited to service in wells which contain fluids and gases which are harmful to synthetic rubber packers. It's designed to form a permanent sealed connection between two



strings of tubing or casing and cement them together in a single run. The seals used are compression type, multiple lead rings, These casing patches are very simple to operate.

LIFTING SUB (2 7/8 -5")

Lifting Sub is made of high-strength alloy constructional steel and processed by heat treatment. Its mechanical properties can meet the requirement of the drill collar; the Sub connections are up to API standard. According to the shape of the up shoulder, the structure includes sloping shoulder and straight shoulder, which can be selected by customs.

CUTTERS

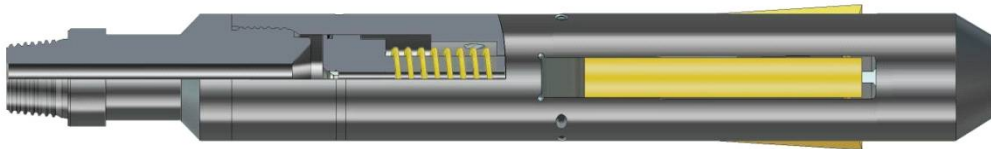

- **Mechanical internal type (1 13/16 – 18 1/16")**
- **Hydraulic internal type (4.37 – 14.48")**
- **Mechanical external type (3 7/8 – 10 1/4")**
- **Hydraulic external type (4 1/16 – 8 1/4")**

MILLS

- Tapered type (3.5 – 27")
- Pilot Junk type (3.82 – 15")
- Junk type (3 1/8 – 16 3/4")

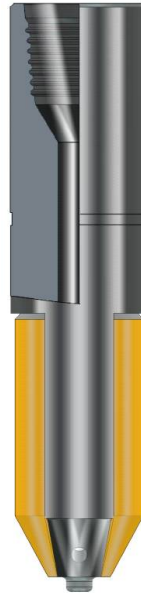

CASING TOOLS

LINER HANGERS

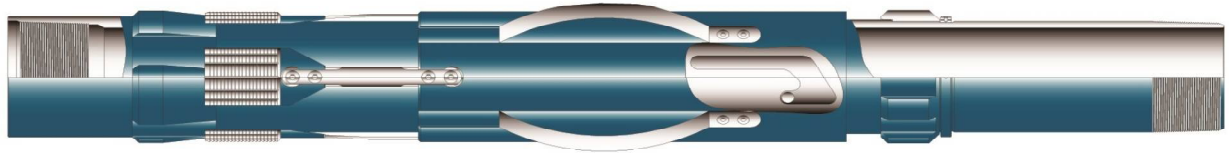

- Mechanical set type
- Hydro type
- Rotating type

STAGE COLLARS

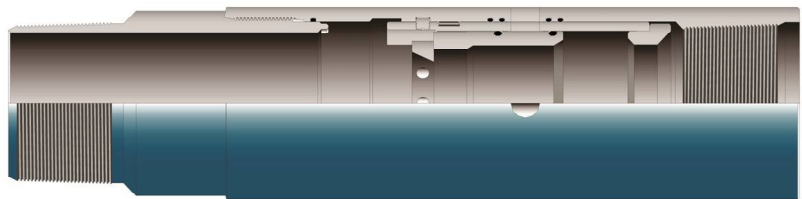

- Mechanical type
- Hydraulic type

PERMANENT PACKER

Permanent Packer installed as casing can result in blocking between casing and well. Rubber assembly as seal, valve assembly control setting. Match with other oil tools can finish most different well blocking.



CEMENTING HEAD

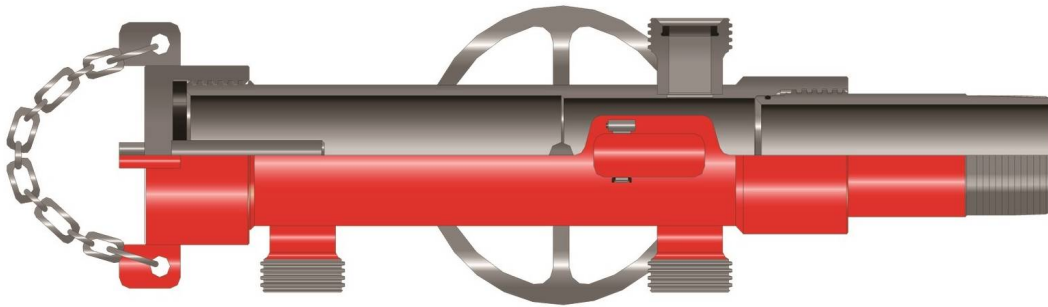

- Acme thread type

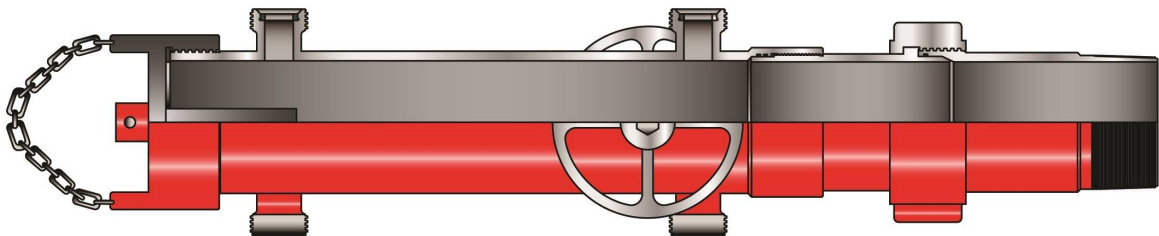

- Union type

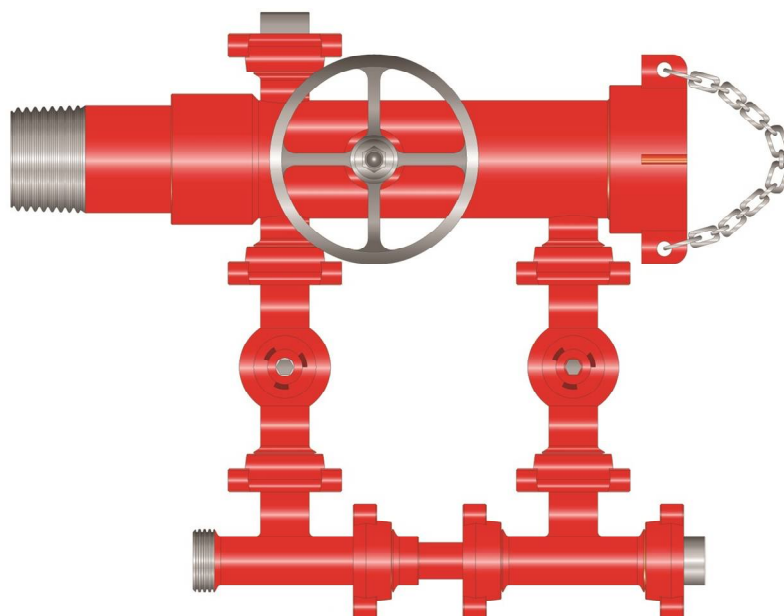

- High pressure manifold type

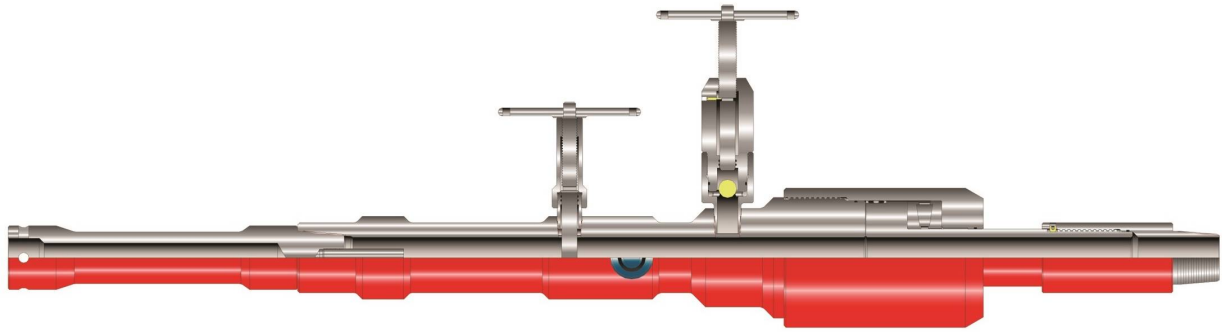

- Rotating type

FLOAT COLLAR

- Typical type
- Flapper valve auto-fill type
- Stab-in spring type
- Auto-fill type

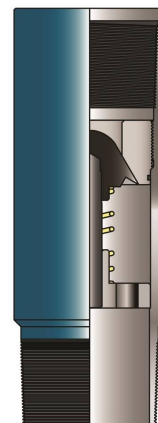

WIPER PLUG

The cement wiper plug contains standard cement wiper plug and non-rotating cement wiper plug. The plugs maintain separation of cementing fluids, wipe casing walls clean, and prevent cement contamination. When bumped against a float collar, they provide positive indication of displacement and casing sealability.

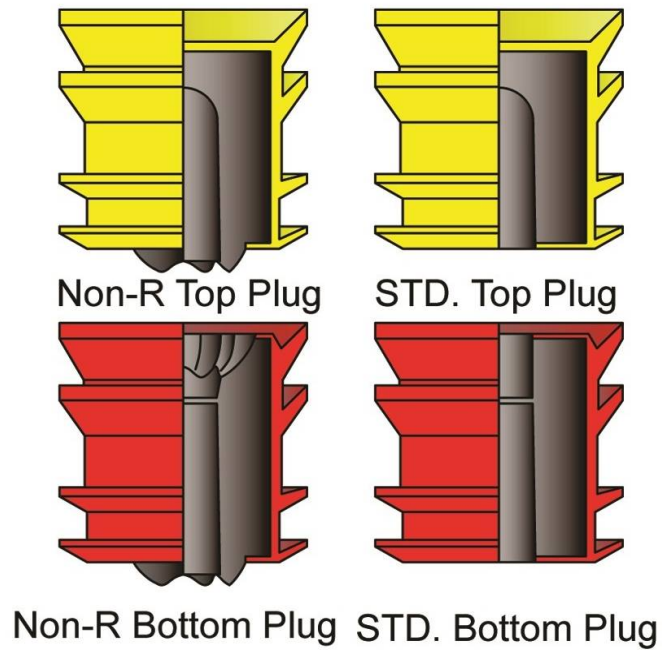

FLOAT SHOES

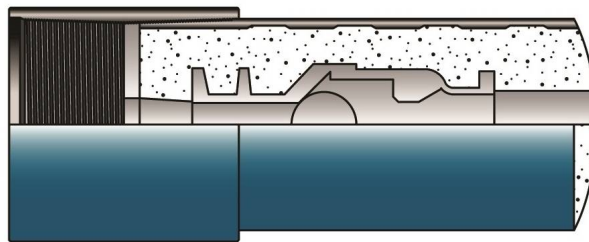

- Typical type
- Auto-fill type
- Flapper valve auto-fill type

CENTRALIZER

Centralizer is used to center the casing in the well. Improve quality of cementing through improving cement flow and reducing effect of channeling.

- Typical type
- Roller type
- Rigid type
- Bow spring type



SUBMERSIBLE PUMPS

Pump model: QZB10000-5.5-240

Flow rate: 10000m³/hr

Head: 5.5m

Rotary speed: 590r/m

Motor power: 240kw

Power voltage: 3000v

Discharge rate: 8-10m/s

Pressure: 4-6T/m²

Solid particles: < 50

Application: remove seafloor sand and slush,
tough and reliable, equivalent to western
brand.



Right photo: For CNOOC Tianjin branch Seabed pipe-laying project 2005



Flow rate: 350m³/hr

Head: 130m

Rotary speed: 1750r/m

Motor power: 240kw

Power voltage: 3000v

Power frequency: 60hz

Above photo: For CNOOC Tianjin branch, Jetting and Suction Pump applied in

seabed trencher (200m below sea water) project.



Motor power: < 260kw

Rotary speed: 3000r/m or 1500r/m

Power system: 380v 50hz

Optional pump pedestal size:

150mm/200mm/250mm/300mm/400mm

For ID of tube protection is far bigger than OD of pumps, suction shield shall be added.

Scope of supply: water pipe, wellhead devices, centralizer and etc.

Left photo: applied in offshore platform and vessel.



Right photo: Sea water submersible pumps for CNOOC 2005.



Above photo: Seabed suction and hammering pump for Tianjin ship company 2005.



Pump model:
QHB2600-12-160
Flow rate: 3600m³/hr
Head: 12m
Rotary speed: 590r/m
Motor power: 160kw

Power system: 3000v 50hz/60hz

Application: Seabed trenching and blowing, high cost efficiency.

Above photo: for CNOOC Tianjin 2006



Pump model: QQN3300-43-560

Flow rate: 3300m³/hr

Head: 43m

Rotary speed: 880r/m

Motor power: 560kw

Power system: 3300v 60hz

Structure feature: low suction

Left photo: for Tainwan Water Corporation,
high pressure and bottom suction high
displacement submersible pump 2004.

Flow rate: 500m³/hr

Head: 3876m

Rotary speed: 2900r/m

Motor power: 680kw

Power voltage: 6000v

Ex-proof level: EII BT4

Application: water injecting for oilfield

Right photo: for domestic oilfield 2006



OILFIELD SERVICES

HWELLEN provides with the following oilfield services:



- Drilling package refurbishment
- Onshore drilling operation



OUR MISSION

We are proudly to be like your own staff of buyers. Just give us a call or an email, we will get you the right items to keep your rigs drilling. In fact, the most valuable thing we get for you is happiness. It's a happiness to chop down your cost, to buy you more time to be with your families and never worry about any call at night to drag you back to work. Life will be easier afterwards.

And if you don't believe, then just give us a chance to serve, that's all we need.

**HWELLEN OILFIELD SERVICES
CO., LTD.**

**Hi-Tech Industrial Development Zone (West),
Chengdu, China
Tel: + 86 28 64433920 FAX: + 86 28 64433920
sales@hwelen.com
www.hwelen.com**